

MODEL NUMBER DAML6274

Variable Gain Low Noise Amplifier

FEATURES

- 0.7-2.1 GHz
- 30 dB Gain
- 1.5 dB Noise Figure
- Variable Gain in 1 dB Steps
- SMA Connectors
- Available in Matched Sets of 2

AMP

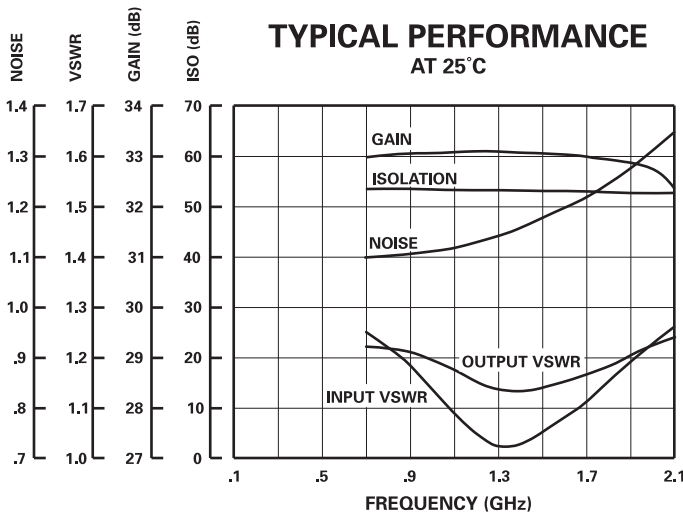
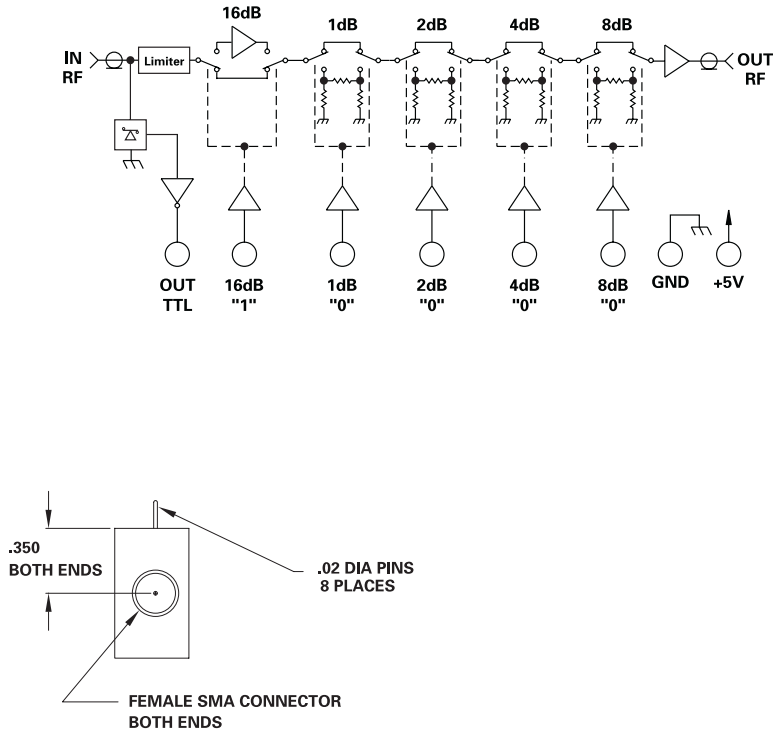
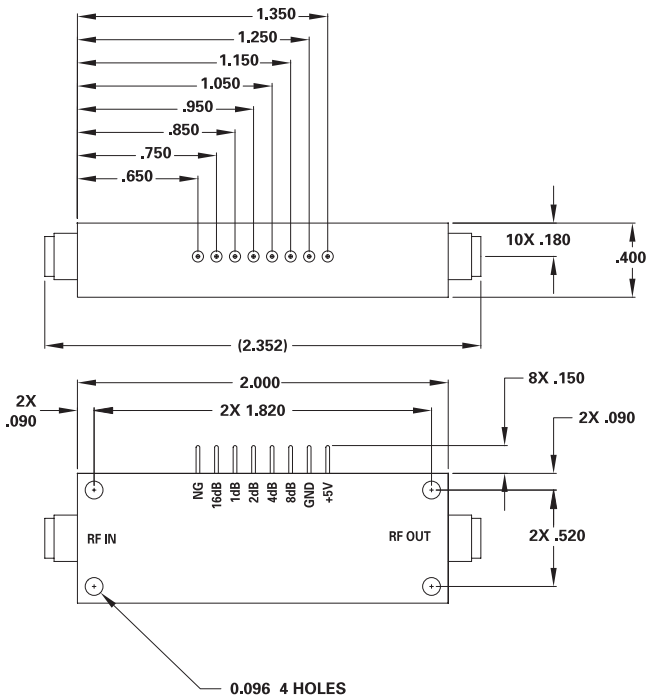

GUARANTEED PERFORMANCE

Parameter	Min	Typ	Max	Units	Conditions
Operating Frequency	700		2100	MHz	
DC Current			350	mA	At +5 VDC Supply
Small Signal Gain	29.5	30		dB	
Control Logic					5 Line TTL, "1" = Attenuation
P out 1 dB Comp	+18	+19		dBm	
Noise Figure		1.35	1.5	dB	At 25°C and 30 dB Gain
VSWR In/Out		1.51/1	1.61/1		
Attenuation	LSB	1		dB	1, 2, 4, 8, 16 dB Bits
	Range	0	31	dB	±(0.3 + 5% of Attenuation Setting in dB) dB
	Accuracy			dB	
3rd Order I.P.	+32	+35		dBm	At 0 Attenuation State
Operating Temperature	-40		+85	°C	TA